



Men's Rapid Fertility Test

# Owner's Guide

# Table of Contents

Precautions and Warnings .....	2
Intended Use .....	3
How it Works .....	3
Before You Begin .....	3
Customer Service .....	3
What's Included .....	4
Engine and Prop Details .....	5
Guidelines for Collecting a Sample .....	6-7
Running the Test .....	8-15
Check for Potential Errors .....	16
Understand Your Sperm Concentration Result .....	17-18
After Testing .....	19
Cleaning .....	19
Disinfection .....	19
Storage .....	19
Test Accuracy .....	19
Frequently Asked Questions .....	20-22

## Precautions and Warnings

- For *in vitro* diagnostic use. Not to be taken internally.
- Keep out of the reach of children.
- Storage: Store in a dry place between 36° F–86° F (2° C–30° C). Do not freeze. Protect from sunlight.
- Do not use after the expiration date printed on system components.
- Certain types of urological infections or recent surgery may interfere with the accuracy of test results.
- Poor vision and/or improper overhead lighting may affect interpretation of test results.
- This system cannot be used to prove paternity.
- This system cannot be used to confirm the success of a vasectomy or as a method of birth control.
- This system does not protect against sexually transmitted diseases.
- DO NOT RE-USE. Props, Volume Cups, droppers, and “seal before spin” stickers are single use only.
- This testing system assesses sperm concentration and semen volume only. It does not detect all male fertility factors.



**WARNING:** Do not use if you suspect that you may have a sexually transmitted infection such as hepatitis, HIV, chlamydia, gonorrhea, or other diseases classified as STDs.

After use, all components of the testing system are considered biohazardous and can potentially transmit infectious diseases.

## Intended Use

The Male Fertility Testing System is intended for semi-quantitative assessment of sperm concentration at 15 million sperm per milliliter (M/mL) or below, between 15 and 55 M/mL, and above 55 M/mL. The System also provides a qualitative assessment of semen volume.

Sperm concentration and semen volume are only two factors that could impact a man's fertility status and time to pregnancy. For complete assessment of male reproductive health, the user should consult a physician. For *in vitro*, over the counter home use.

## How it Works

The sperm concentration test uses centrifugal force to isolate sperm cells from a semen sample. Any sperm cells present form a white column in the Prop channel. The height of the column correlates with the concentration of the sperm cells in the sample. The Volume Cup accumulates semen into a defined space to indicate semen volume.

Sperm Concentration
Low (15 M/mL or below)
Moderate (Between 15 & 55 M/mL)
Optimal (Above 55 M/mL)
Semen Volume
Low (1.5 mL or below)
Normal (Above 1.5 mL)

## Before You Begin

- Read and understand these instructions.
- Check expiration dates for all system components.
- Install Engine batteries. New batteries will last approximately 15 tests. Use AA alkaline batteries only.
- A clock or timer is required, but not included.
- Consider running a control test prior to running a real test. Control solution is available through customer service.
- Super Sani-Cloth® wipes are recommended to disinfect your Engine after use and are available for purchase online.
- Please allow 45 minutes after collecting your sample to complete a test.

## Customer Service

For technical support or if you have any questions or concerns about the Men's Rapid Fertility Test, contact:

**800-833-3935**

**Monday–Friday, 8:00am–6:00pm ET.**

**[ondemand.labcorp.com](http://ondemand.labcorp.com)**

## WHAT'S INCLUDED



If any components of the system are missing or damaged, contact customer service at **800-833-3935** Mon-Fri, 8 am-6 pm, ET. Control solution is also available through customer service if you would like to run a practice test.

# ENGINE AND PROP DETAILS

## Engine

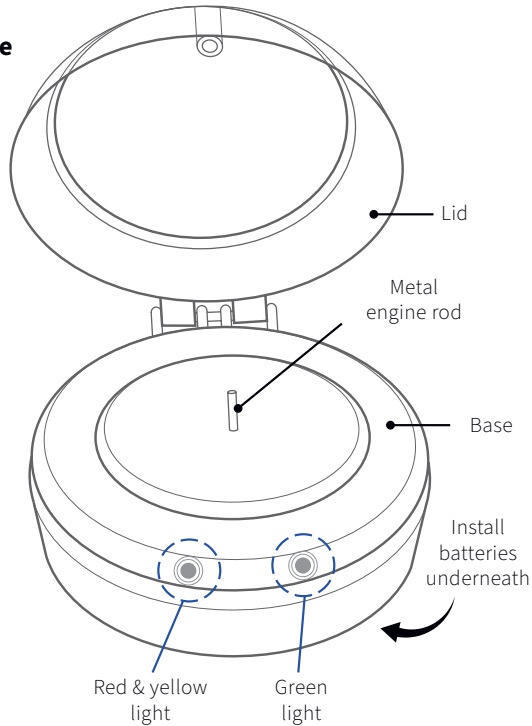

## Prop

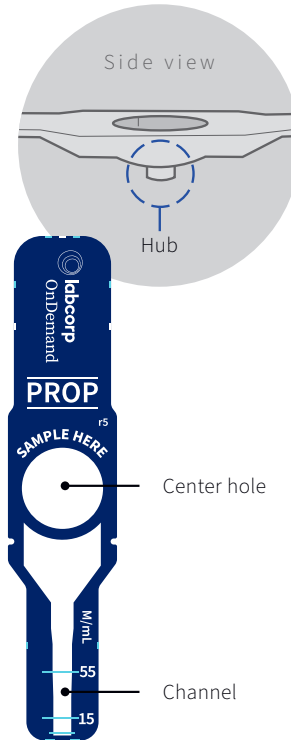

## GUIDELINES FOR COLLECTING A SAMPLE

### Wait 2 to 7 days without ejaculating before collecting a sample

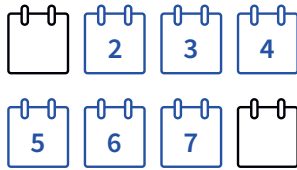

At less than 2 days, sperm concentration may be low. At more than 7 days, sperm concentration may be high and full of dead cells.

### In the meantime, educate yourself

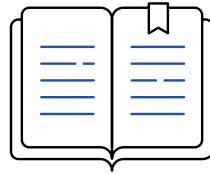

Get familiar with the test and materials. Review the Men's Health Guide to identify ways to make improvements to your reproductive health.

### When repeat testing over time, consistency is key

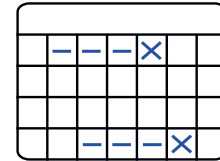

If you go without ejaculating for 3 days before collecting a sample the first time, it is best to go without ejaculating for 3 days before collecting a sample the next time.

## Do not use condoms or lubricants when collecting a sample

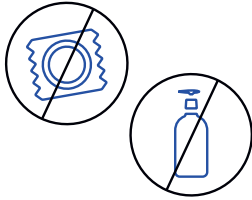

Materials in condoms and lubricants kill sperm. Collection via sexual intercourse is also not recommended.

## Volume Cups: what to expect

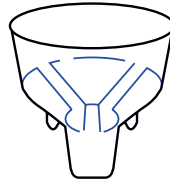

The Volume Cups included with your kit are coated with enzymes for fast and reliable testing. They may appear wet, sticky, or flakey — this is completely normal!

## Have your sample Volume Cup ready and within reach

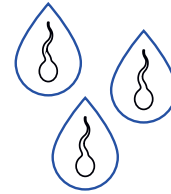

Most sperm live in the first drops of ejaculate, so have your Volume Cup within reach to make sure you collect the entire sample.

## RUNNING THE TEST: COLLECT A SAMPLE

# Let's do this!

**To ensure an accurate result, review the guidelines on page 5 for collecting a semen sample.**

Protective gloves are recommended if performing the test for someone else. Always wash your hands well with soap and water before and after handling the Collection Volume Cup, dropper, Prop, or Engine.

Be sure that batteries have been installed in the Engine before running a test.

**Note:** A red light will flash briefly to indicate that new batteries have been installed correctly.

### Helpful icons:

☆ Tips or additional information.

! Situations that may indicate an error and possibly inaccurate test result.

# 01

Collect a semen sample in the provided Collection Volume Cup. Place lid on cup.

☆ Only use the specially treated cups included in the kit. A residue may be visible due to the enzyme coating the cups.

! If you miss the cup or have a very low sample volume, discard the Volume Cup and try again in 2 to 7 days.

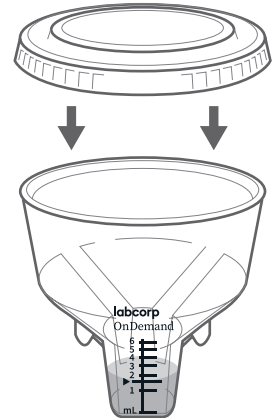



## RUNNING THE TEST: READ AND RECORD SEMEN VOLUME RESULT

# 02

Swirl the cup for at least 15 seconds.



# 03

You need to wait 30 minutes for the sample to liquefy at room temperature before running the test. The test can be performed up to 2 hours after sample collection.



# 04

Place the cup so that the top of the liquid is even with your eyes. Look straight at the cup.

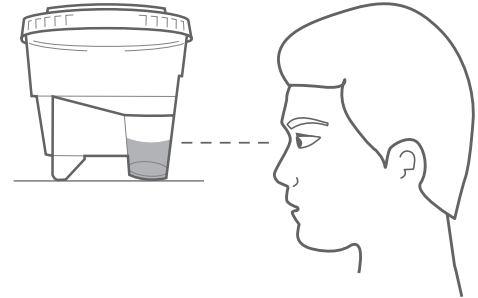

★ If the cup is tilted, the liquid level may look higher or lower than it actually is.

## RUNNING THE TEST: READ AND RECORD SEMEN VOLUME RESULT

# 05

Find the top of the liquid. Be sure to read the liquid level **from the center** because it may curve up at the edges. **Record your semen volume result before testing sperm concentration.**

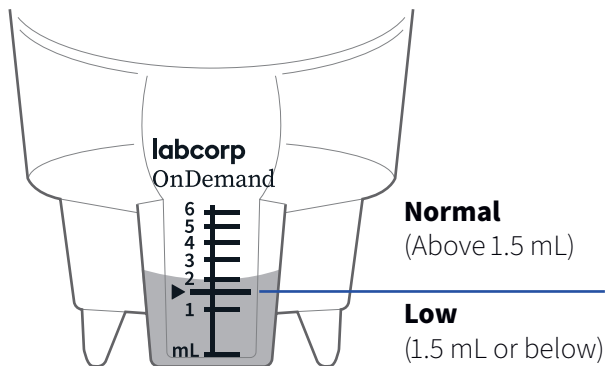

★ Men with low semen volume (<1.5 mL) may be at risk of infertility and/or urological conditions and should consult a physician.

# 06

After reading the volume result, swirl the Volume Cup again for **at least 15 seconds** to evenly distribute the sperm cells. Remove the lid from the Volume Cup.

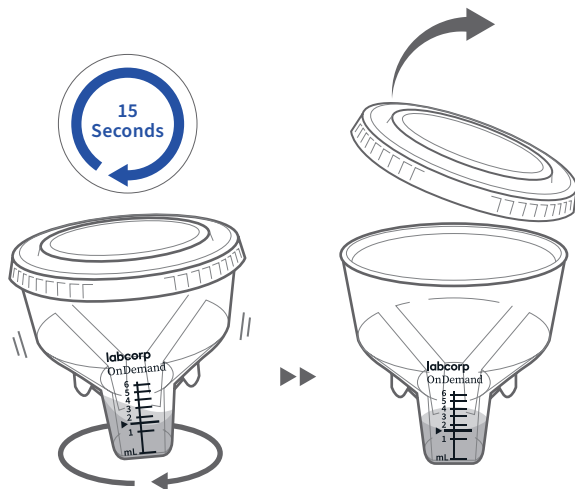

## RUNNING THE TEST: PREP THE SAMPLE

# 07

Remove the contents from one test bag.



★ An extra dropper and sticker are included in each test bag if needed.

# 08

Open the Prop pouch and remove the Prop. Remove the foil seal from the Prop. Discard pouch and foil seal into the empty test bag.

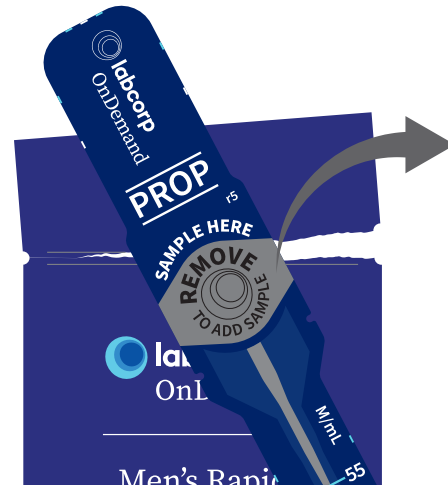

## RUNNING THE TEST: LOAD THE SAMPLE

# 09

Pick up the Volume Cup. Pick up the dropper. Squeeze the **top** bulb of the dropper, and then insert the open tip of the dropper into the deepest part of the sample (to avoid loading bubbles). Release the top bulb to fill. Make sure the “stick” part of the dropper is completely full.

★ The bottom bulb is for overflow and should partially fill.

! If a whole sample is collected, but there isn't enough to fill the dropper, discard the cup and dropper and try again in 2 to 7 days.

! If your sample is too thick to load, leave the sample in the cup for at least 15 additional minutes, or up to 2 hours after sample collection. Be sure to swirl the cup for at least 15 seconds before filling the dropper.

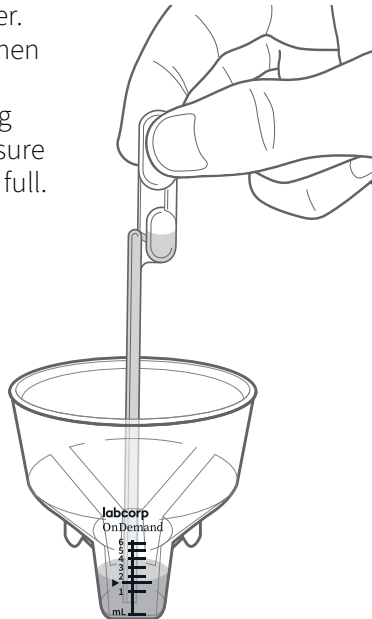

# 10

Insert the open tip of the dropper into the center hole of the Prop. Squeeze the **top** bulb to empty the sample.

★ The bottom bulb of the dropper will not empty.



## RUNNING THE TEST: LOAD THE SAMPLE

Use **one** dropper load only. Discard dropper into an empty test bag. Place lid on cup and set aside.

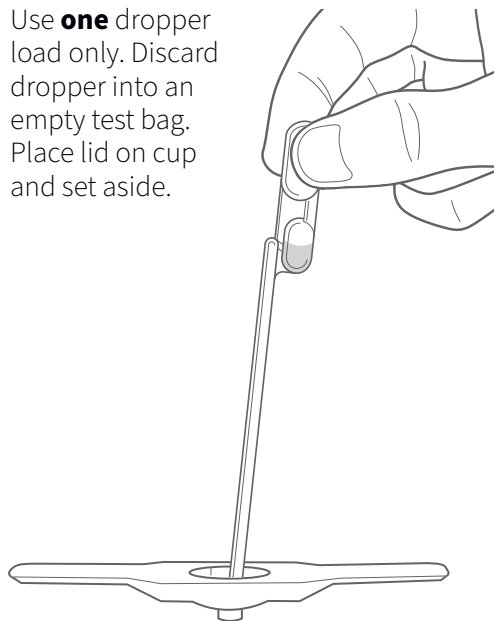

# 11

Seal the Prop with a “Seal Before Spin” sticker.

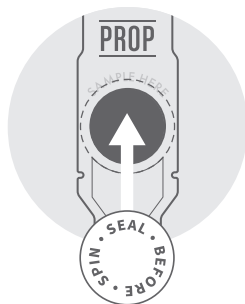

# 12

Place the Engine on a flat, stable surface. Open the lid. Pick up the Prop. Attach the Prop to the Engine by pressing it firmly onto the metal Engine rod.

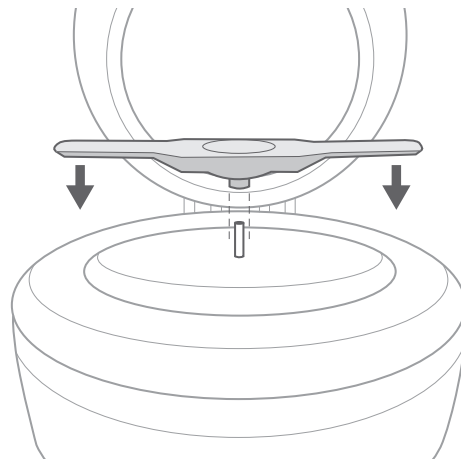

## RUNNING THE TEST: SPIN THE PROP

# 13

Close the lid. The test will begin automatically. **Do not open while the Prop is spinning.** The test will complete in about 6 minutes.



★ A green light blinks twice to indicate that the batteries are good and the Prop was properly detected. The following yellow light indicates the test is in progress. Do not open the lid while the yellow light is on.

- ❗ **No light:** If there is no light at all, there probably aren't any batteries in the Engine.
- ❗ **Single red light flash:** The Engine didn't detect the Prop and will not start. Try to push the Prop on more securely. If the Prop will not attach securely, you may need to start over with a new Prop, dropper, sticker, and any remaining sample in the Volume Cup.
- ❗ **Slow blinking red light:** The batteries are low.

# 14

When the Engine stops, a solid green light will indicate that the test is complete. Open the lid, remove the Prop, and place it on a flat surface. The test result must be read within 3 minutes.

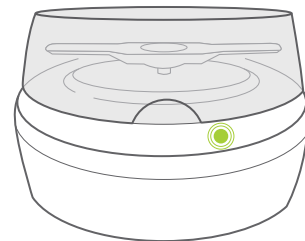

## RUNNING THE TEST: READ YOUR SPERM CONCENTRATION RESULT



**Read result  
within 3  
minutes**

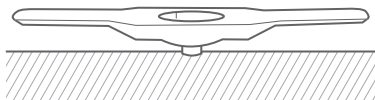

★ You should read the Prop in a room with good overhead lighting.

❗ **Red light:** If the Prop is left in the Engine for longer than 3 minutes, the red light will illuminate. This means the result is invalid, and you will need to run another test with a new Prop, dropper, sticker, and any remaining sample in the Volume Cup.

❗ **Blinking red light:** A blinking red light indicates an error (for example, the lid was opened before the test was complete) and the test result is not valid. Repeat the test with a new Prop, dropper, sticker, and any remaining sample in the Volume Cup.

### Read your test result

Look straight down at the Prop channel to read your result.



★ Looking at the Prop channel at an angle can cause the white column to appear taller or shorter than it actually is.

# 15

**Test complete!**



See page 16 for information on possible errors in the test result. If there is no error, see page 17 for details on reading your result.

## RUNNING THE TEST: CHECK FOR POTENTIAL ERRORS

Examine the Prop carefully to make sure you do not see any of the following errors.

**Make sure there are no clogs.** If you see a clog, run the test again with a new Prop, dropper, sticker, and any remaining sample in the Volume Cup.

❗ The main reason for clogs is not swirling the sample well. Make sure you swirl the sample for at least 15 seconds before filling the dropper.

**Make sure there is no red** at the bottom of the white column. If your Prop has any red discoloration, do not run another test and consult a physician.

❗ Red discoloration may indicate the presence of blood in the sample.

**Make sure there are no air bubbles.** If you see one or more air bubbles, run the test again with a new Prop, dropper, sticker, and any remaining sample in the Volume Cup.

❗ There may not be enough sample in the Prop. Make sure you add one full dropper load of sample.

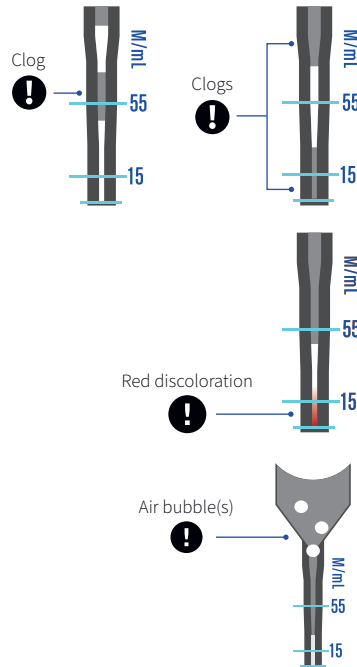

☆ If there is **no white column**, run another test in 2 to 7 days. Contact customer service to request a control test if you think your device may not be functioning properly or would like to confirm you are performing the steps correctly. If there is no white column the second time you run a test and your sperm concentration is low, you are advised to consult a physician. Refer to the FAQs on page 20 for more information.



## RUNNING THE TEST: UNDERSTAND YOUR RESULTS

### Understand Your Sperm Concentration Result

Locate the top of the white column in the Prop channel. The height of the white column determines your result.

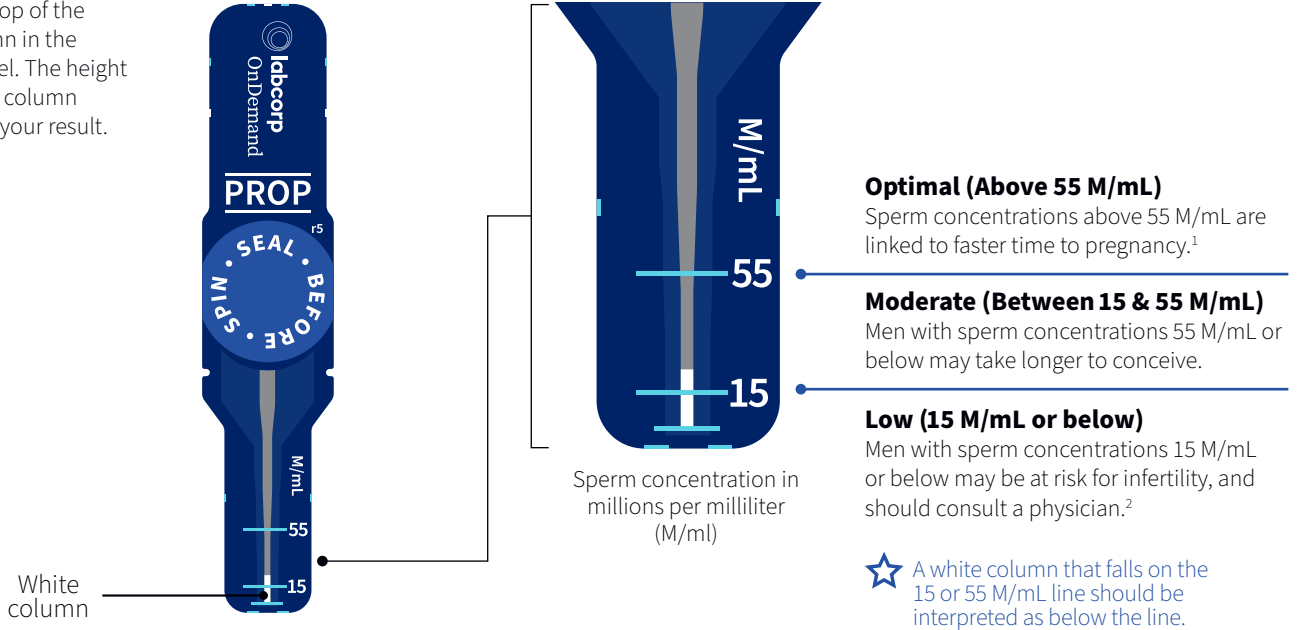

<sup>1</sup>Slama, R. Time to pregnancy and semen parameters: a cross-sectional study among fertile couples from four European cities. Human Reproduction. Vol.17, No. 2 pp 503-515, 2002.

<sup>2</sup>World Health Organization. WHO Laboratory Manual for the Examination and Processing of Human Semen. 5th Edition, 2010.

## Understanding Both Results

Semen volume and sperm concentration are two different semen measurements. Each one may affect your fertility. **If either one or both results are low**, you may be at risk for infertility and should consult a physician. See the FAQs for a list of specific result combinations that indicate possible risk for infertility.

Sperm Concentration
Low (15 M/mL or below)
Moderate (Between 15 & 55 M/mL)
Optimal (Above 55 M/mL)
Semen Volume
Low (1.5 mL or below)
Normal (Above 1.5 mL)

## After Testing

Semen collected in a Collection Volume Cup can only be used for testing with the Men's Rapid Fertility Test. Please discard remaining sample after testing. Volume Cups, Props and droppers are single use only and should also be discarded after use. To discard, re-cap the volume cup and place all used items in the test accessory bag, then discard in the trash.

Do not get any liquids, dirt, dust, semen, or control solution inside the Engine through the motor opening or battery compartment. Do not immerse the Engine in any liquid.

## Cleaning

Cleaning is the physical removal of dirt from the Engine. To clean your Engine, wipe the Engine base and lid with water and mild detergent. Clean the Engine when visibly dirty.

## Disinfection

Disinfection is the removal of most, but not all, disease-causing pathogens from the Engine.

Approved disinfection product: Super Sani-Cloth® (EPA reg. no. 9480-4). Available for purchase from online retailers.

To disinfect your Engine, wipe the Engine base and lid with the approved Super Sani-Cloth® product. The surfaces must remain wet for a full two (2) minutes. Do not use other disinfecting products.

Disinfect the Engine if it is exposed to semen. Disinfect the Engine before allowing anyone else to handle the Engine.

When finished, thoroughly wash your hands with soap and water.

## Storage

Store your Engine, Prop pouches, and other unused system components in the kit until the next use. You may leave the batteries in the Engine with the lid closed. The Engine will run approximately 15 tests before the batteries need to be replaced.

Store your kit in a dry place between 36° F–86° F (2° C–30° C).

## Test Accuracy

In a study of subjects aged 18–68 years, the Volume Cup showed an accuracy of 96% compared to a standard laboratory test.

In a separate clinical study of 239 subjects aged 20–49 years, the Men's Rapid Fertility Test showed the following accuracy compared to a standard laboratory test: <15 M/mL (93.3%), 15–55 M/mL (82.4%), >55 M/mL (95.5%).

Factors that may impact test accuracy include:

- Presence of white blood cells, most commonly occurring due to infection or recent surgery.
- Abstaining for less than 2 days or greater than 7 days prior to collecting a sample.
- Not collecting the full ejaculate in the Volume Cup, particularly the first portion.
- Not swirling the cup sufficiently before adding sample to the Prop.
- Not adding enough sample to the Prop.
- Reading results at an angle or with inadequate overhead lighting.

To ensure test accuracy, pay close attention to the guidelines for running the test. Truly abstain, make sure to collect a full sample, and swirl the sample properly in the Volume Cup.

If you need more help, visit [ondemand.labcorp.com](https://ondemand.labcorp.com) or contact customer service at 800-833-3935.

Support available Mon-Fri, 8 am-6 pm, ET

## FREQUENTLY ASKED QUESTIONS

### **What if I don't collect the whole sample?**

Do not complete a test with this sample. Discard the Volume Cup and lid, and try to collect a sample again in 2 to 7 days with a new Volume Cup. It is important to collect an entire sample in the provided Volume Cups. If you don't collect the entire sample, particularly the first drops, your result may not be an accurate reading of sperm concentration.

### **What should I do if my sample is too thick to fill the dropper after 30 minutes?**

The included Volume Cups are specially treated with an enzyme (Chymotrypsin) to reduce the viscosity of the semen sample. Most samples will be thin enough to fill the dropper within 30 minutes after collection. If your sample is still too thick to fill the dropper, cap and swirl the cup again, and wait longer. Waiting up to 2 hours before starting the test is acceptable. If the sample remains too thick after 2 hours, discard the Volume Cup and sample, and test again in 2 to 7 days with a new Volume Cup. Drinking lots of water during the 24 hours before testing may help produce a more liquid sample.

### **Can my medication affect my test result?**

Possibly. Certain medications may affect sperm concentration or semen viscosity. Consult a physician for guidance.

### **Does it matter how much sample I add to the Prop?**

Yes. The included droppers are specially designed to dispense a precise amount of semen to the Prop. It is important to add one, and only one dropper load (one full length of the “stick” part of the dropper) of the sample into the Prop.

### **Can I re-use the dropper?**

No. The droppers are designed to add a precise amount of liquid to the Prop. If a dropper has been used it may not function correctly.

### **Why do I need to look straight down at the Prop to read a test result?**

Results may be misinterpreted if the Prop is viewed at an angle other than straight down because the sperm cells are contained inside the Prop while the 15 and 55 blue lines are printed on top of the Prop.

### **What does it mean if I don't see a white column in my Prop?**

No white column in the Prop channel indicates a low sperm concentration result. You are advised to run another test with a new Volume Cup, Prop pouch, dropper, and sticker in 2 to 7 days. Be sure to carefully read and follow all test steps. If you have not already done so, you are also recommended to run a control test to ensure proper use of the system. Control solution is available through customer service. If you don't see a white column a second time, consult a physician.

### **Does a result 15 M/mL or below indicate that I am infertile?**

Not necessarily. A low result indicates that your sperm concentration is lower than most fertile men.<sup>2</sup> Sperm concentration can also vary day to day and may be affected by other health, wellness, and lifestyle habits. You are advised to consult a urologist specializing in male reproductive health for a medical evaluation and guidance.

### **Does a result above 15 M/mL indicate that I am fertile?**

Not necessarily. Sperm concentration is an important indicator of male reproductive health, but there are other factors including sperm motility, sperm morphology, semen volume, semen viscosity, anti-sperm antibodies, genetic abnormalities, etc. You are advised to seek medical guidance if you and your partner have been trying to conceive unsuccessfully for 12 months or longer.

### **Does a result above 55 M/mL mean we will get pregnant faster?**

Not necessarily. Sperm concentrations above 55 M/mL were tied to faster time to conception versus sperm concentrations below that value in a study of 942 couples.<sup>1</sup>

### **Does a semen volume of 1.5 mL or below indicate that I am infertile?**

Not necessarily. A low semen volume result indicates that your volume is lower than most fertile men.<sup>2</sup> You are advised to consult a urologist specializing in male reproductive health for a medical evaluation and guidance.

## FREQUENTLY ASKED QUESTIONS

### What sorts of results indicate an elevated risk for infertility?

Any **low** result, in any combination. The following combinations of results indicate a possible risk for infertility:

**Low** semen volume and **low** sperm concentration

**Low** semen volume and moderate sperm concentration

**Low** semen volume and optimal sperm concentration

Normal semen volume and **low** sperm concentration

If you receive a **low** result in just one semen measurement, you may have a risk for infertility and should consult a physician.

<sup>1</sup> Slama, R. Time to pregnancy and semen parameters: a cross-sectional study among fertile couples from four European cities. Human Reproduction. Vol.17, No. 2 pp 503–515, 2002.

<sup>2</sup> World Health Organization. WHO Laboratory Manual for the Examination and Processing of Human Semen. 5th Edition, 2010.



# Men's Rapid Fertility Test

**[ondemand.labcorp.com](https://ondemand.labcorp.com)**

**800-833-3935**

**Support available Mon-Fri, 8 am-6 pm, ET**

Manufactured by  
MEDTOX® Diagnostics, Inc.  
6624 Owens Drive  
Pleasanton, CA 94588

